

**FICHE D'HOMOLOGATION
HOMOLOGATION FORM**



**COMMISSION INTERNATIONALE
DE KARTING – FIA**



PROTECTION ARRIERE / REAR PROTECTION

Constructeur	<i>Manufacturer</i>	Tony Kart s.r.l.
Marque	<i>Make</i>	OTK
Modèle	<i>Model</i>	M4
Catégorie	<i>Category</i>	Toutes / All
Durée de l'homologation	<i>Validity of the homologation</i>	6 ans / years
Nombre de pages	<i>Number of pages</i>	4

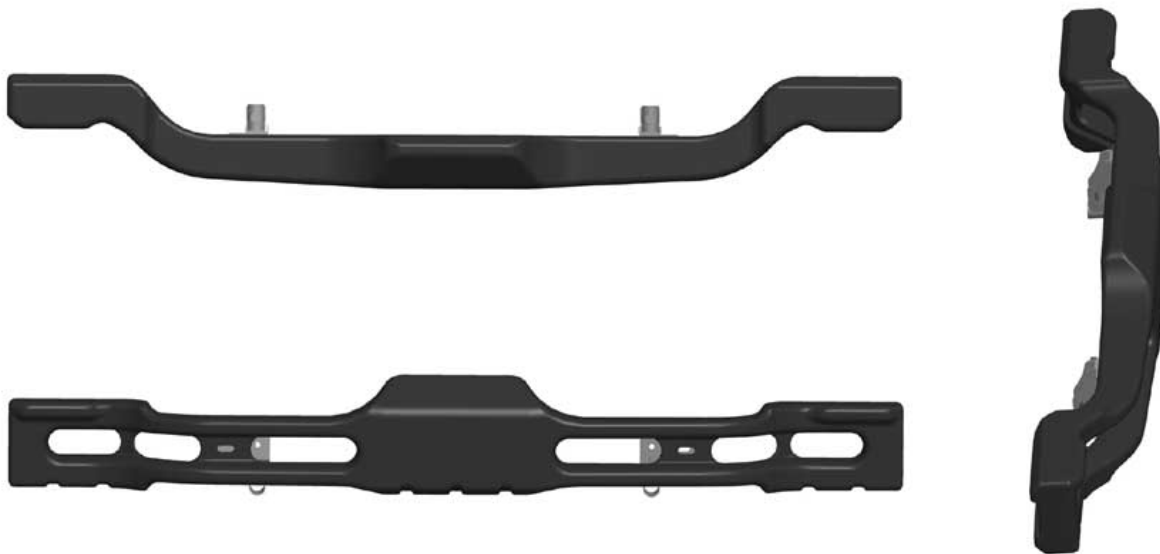

La présente Fiche d'Homologation reproduit descriptions, illustrations et dimensions au moment de l'homologation CIK-FIA.

This Homologation Form reproduces descriptions, illustrations and dimensions at the moment of the CIK-FIA homologation.

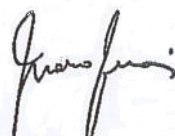

PHOTOS VUE DE DERRIERE, DE DESSUS ET DE COTÉ, DE LA PROTECTION ARRIERE AVEC SES SUPPORTS

PHOTO FROM REAR, ABOVE AND SIDE OF REAR PROTECTION WITH ITS SUPPORTS

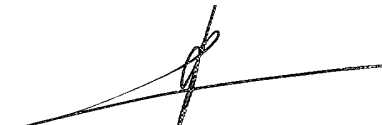
Signature et tampon de l'ASN <i>Signature and stamp of the ASN</i>	Signature et tampon de la CIK-FIA <i>Signature and stamp of the CIK-FIA</i>
 	 

PROTECTION ARRIERE - CARROSSERIE
Dessin technique (dimensions d'encombrement)

REAR PROTECTION - BODYWORK
Technical drawing (main external dimensions)

Poids en g (carrosserie seule)

Weight in g (bodywork only)

1400 g

+/-10 %

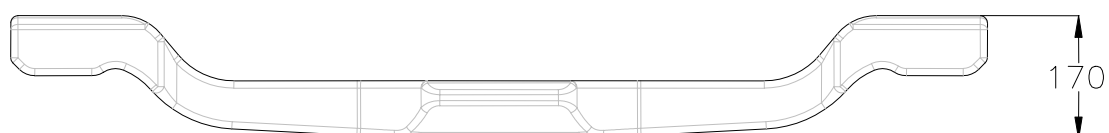
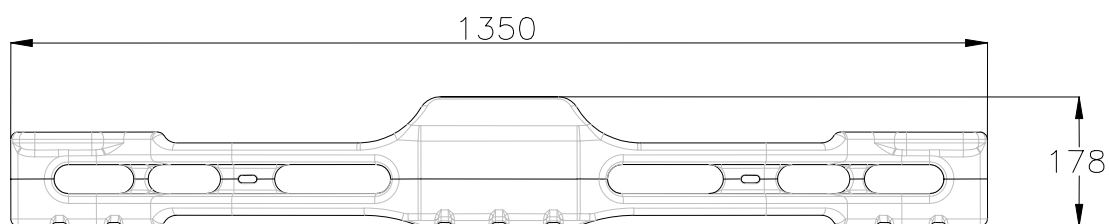

PHOTO (carrosserie seule) / (bodywork only)



SUPPORTS DE FIXATION
Dessin technique éclaté**ATTACHMENT SUPPORTS**
Exploded technical drawing

Poids en g

*Weight in g***700 g**

+/-5 %

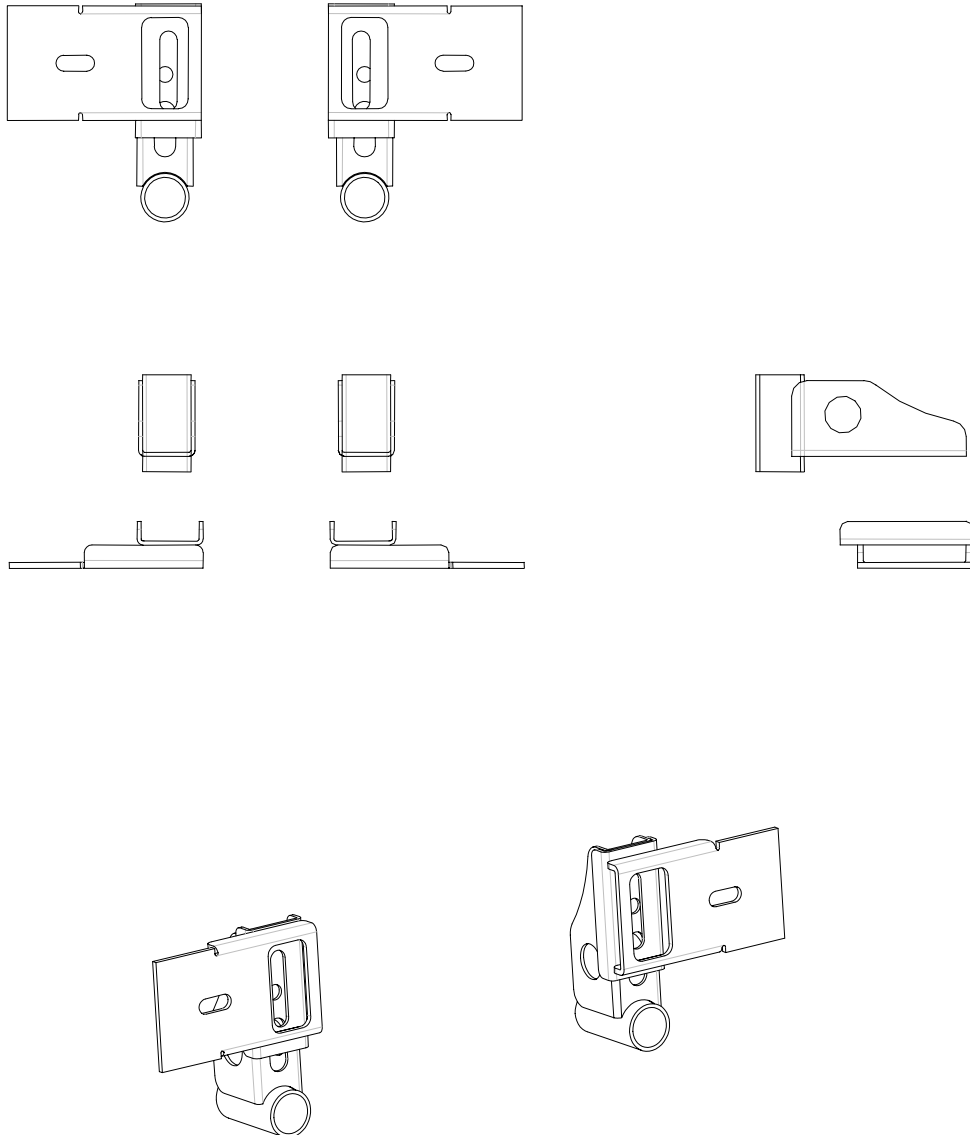

PHOTO DU MARQUAGE DU NUMERO
D'HOMOLOGATION (et du logo CIK-FIA sur les
éléments plastiques)

PHOTO OF THE HOMOLOGATION NUMBER
MARKING (and of the CIK-FIA logo on the
plastic parts)

Le marquage doit rester clairement visible en permanence
The marking must be clearly visible at all times

CARROSSERIE

BODYWORK



SUPPORTS

